

Art. Nr. 2824696  
1/6



31.10.2023

Art. Nr. 2824696

Groundplan - Grundplan - Plan de masse - Planimetria -  
Plattegrond - Põhiplaan

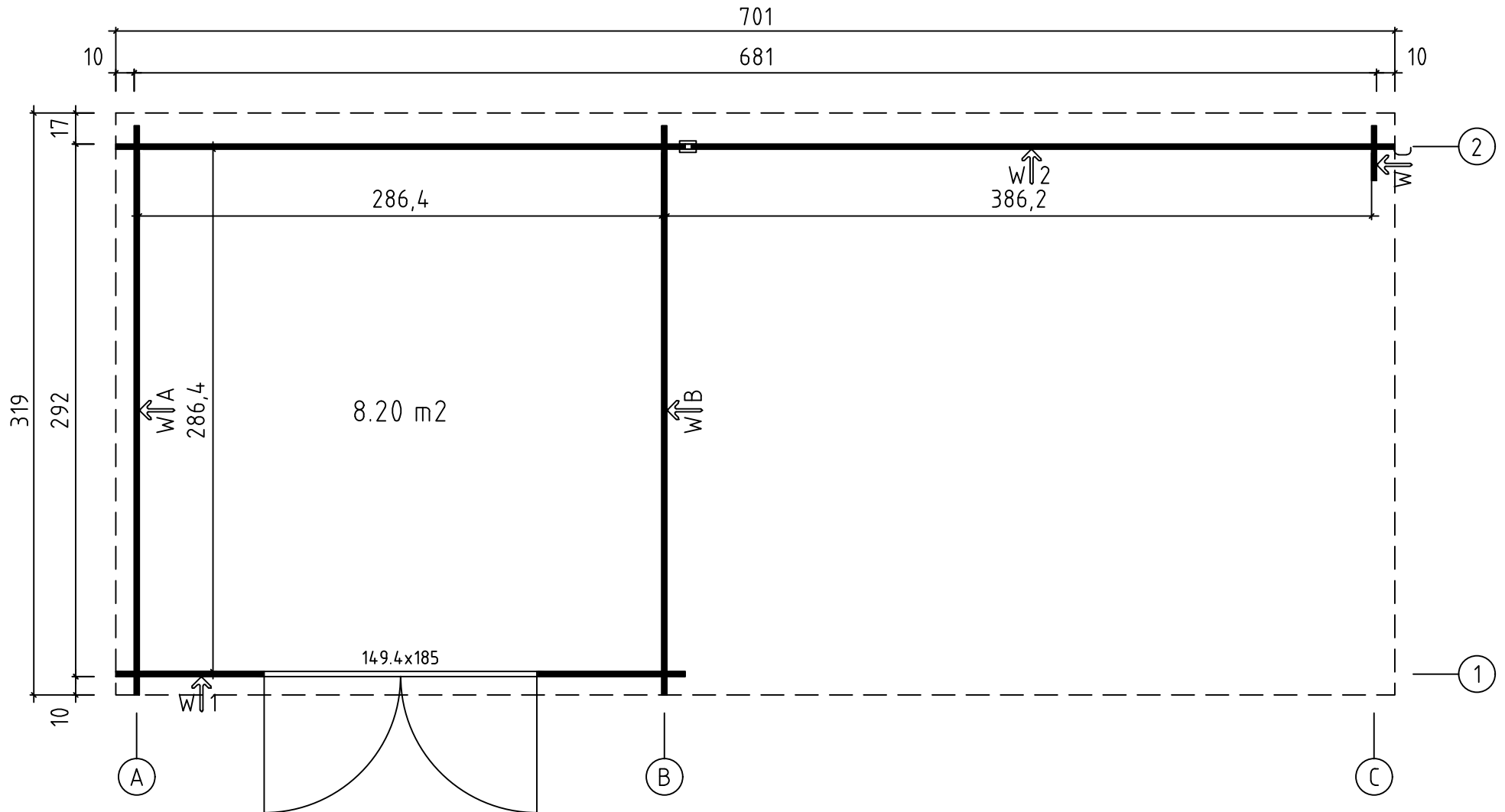







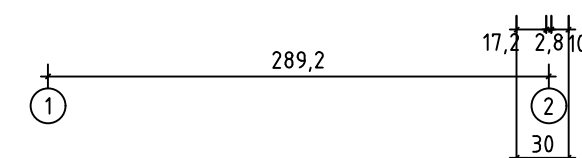
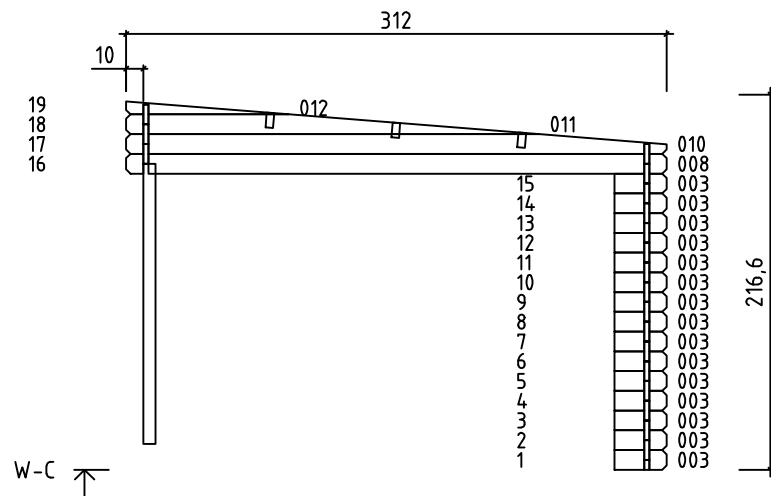
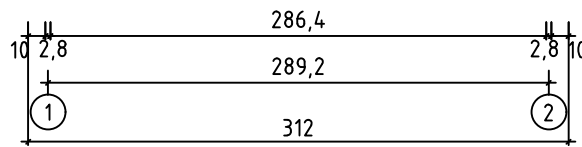
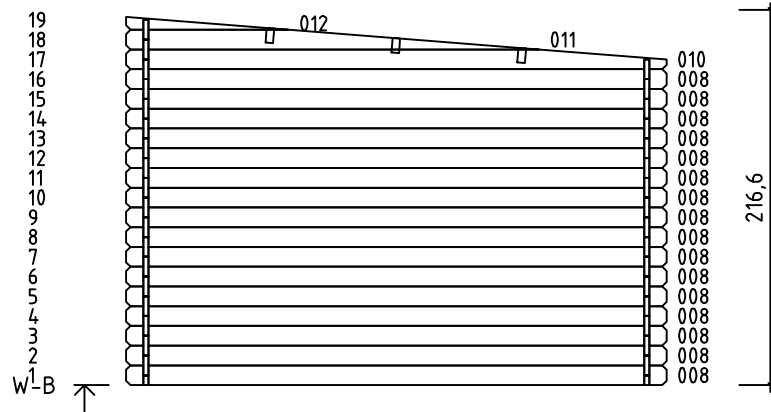
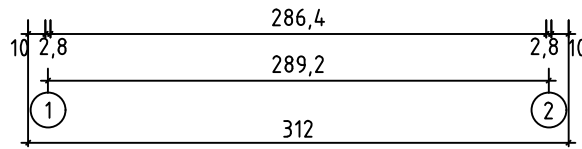
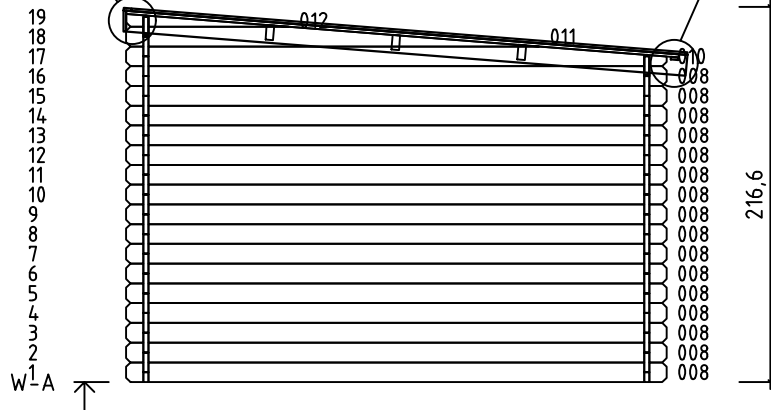
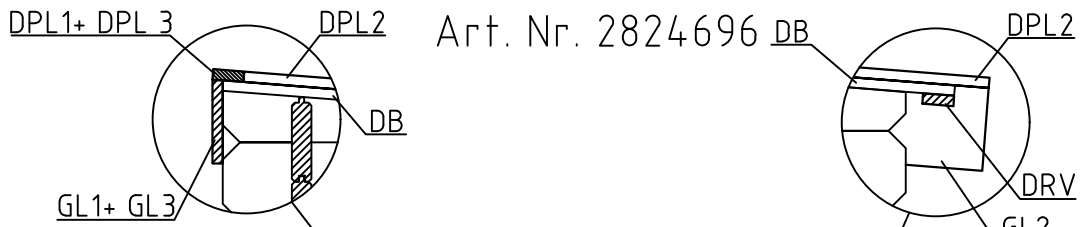

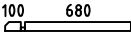
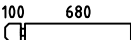

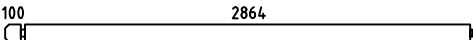
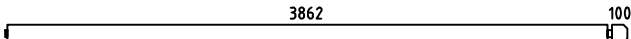
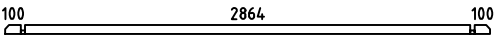
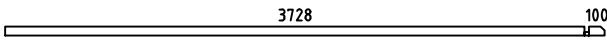
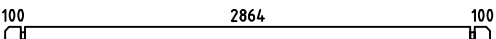
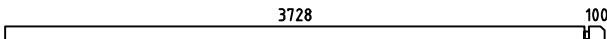
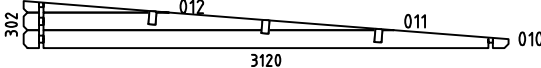
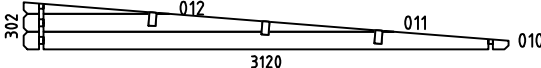
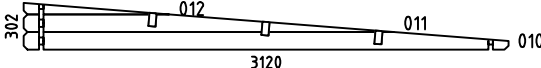
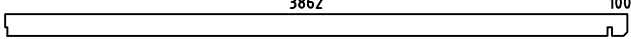
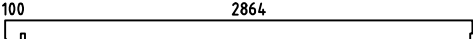

31.10.2023



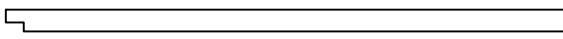

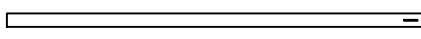

2/6



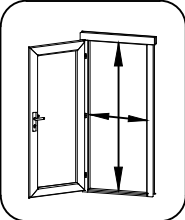
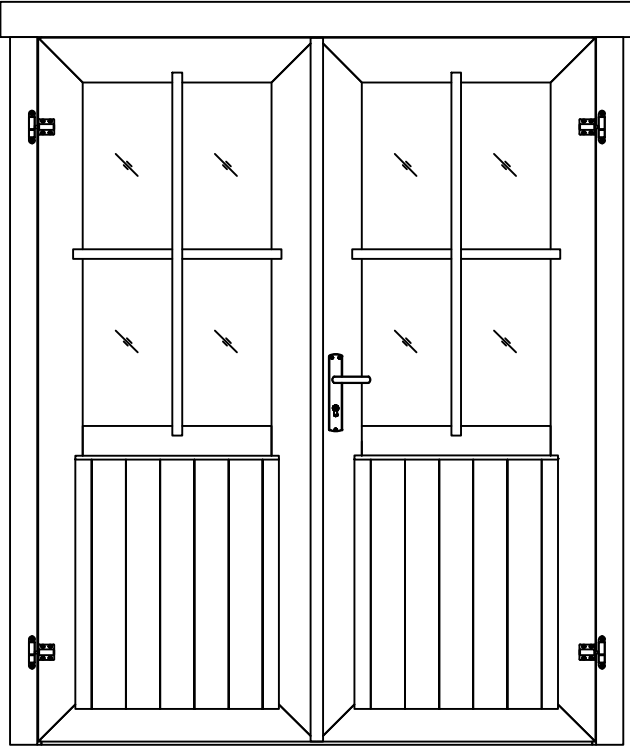

Pos	31.10.2023 Piece list - Stückliste - Liste des pièces - Elementi - Stuklijst - Tükítabel Art. Nr. 2824696 5/6	Q	P (mm)	L (mm)
001 22693		2	28x57	808
002 22694		32	28x114	808
003 1800		16	28x114	300
004 27902		3	28x114	3006
005 27903		3	28x114	4004
006 22696		1	28x57	3120
007 27904		1	28x57	3856
008 22697		48	28x114	3120
009 27905		15	28x114	3856
WA-1 27588		1		
WB-1 27588		1		
WC-1 27588		1		
A-PR2 27908	Roof beam - Dachbalken - Panne de toit - Perlina del tetto - Gordingen / dakbalk - Pärтин 	3	44x146	4004
A-PR1 27907	Roof beam - Dachbalken - Panne de toit - Perlina del tetto - Gordingen / dakbalk - Pärтин 	3	44x146	3006
DB 6900	Roof boards - Dachbretter - Voliges - Perlina per tetto - Dakhout - Katuselaud 	78	90x15.5	3200
27597	H-profile - H-profilis - Profile H - Profilo ad H - H-profiel - H-profiil 	1	58x90	1820
DPL1 27592	Roofing felt fillet - Dachpappenleiste - Baguette de fixation du feutre bitumeux - Asse per fissaggio guaina bituminosa - Afdeklijst asfaltpapier - Katusepapiilist 	1	15x45	3021
DPL2 25870	Roofing felt fillet - Dachpappenleiste - Baguette de fixation du feutre bitumeux - Asse per fissaggio guaina bituminosa - Afdeklijst asfaltpapier - Katusepapiilist 	2	15x45	3220
DPL3 27909	Roofing felt fillet - Dachpappenleiste - Baguette de fixation du feutre bitumeux - Asse per fissaggio guaina bituminosa - Afdeklijst asfaltpapier - Katusepapiilist 	1	15x45	4019
p 35256	Post - Pfosten - Poteau - Piede registrabile - Stijl - Post 	1	70x70	1662
DRV 27910	Roof edge reinforcement - Dachrandverstärkung - Corniere de renfort de bord de toit - Rinforzo x tetto - Dakrand versterking - Rääsfatugevdus 	2	15x45	3505
KFS-1 2249	Storm protection - Sturmleiste - Latte anti-tempete - Protezione anti vento - Stormverankerung / beveliging - Tormikinnusliist 	5	22x45	2050
GL1 27595	Gable moulding - Giebelleiste - Planche de rive - Finitura per frontale e retro del tetto - Gevellijst - Viululaud 	1	15x120	3021

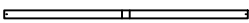
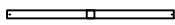

Pos	18.12.2017	Piece list - Stückliste - Liste des pièces - Elementi - Stuklijst - Tükítabel 14.94x1850 TUK.2.044.SVP.MX28 SGA+28	1/2	Q	P (mm)	L (mm)
Glass size - Glasgröße - Taille de la vitre - Misura del vetro - Glas afmeting - Klaasi mõõt: 502x900 mm					 1418x1794 mm	
						
1	Upper door jamb - Türrahmen oben - Cadre de porte supérieur - Telaio superiore della porta - Bovendorpel - Ukse ülemine leng			1	66x100	1438
2	Left door jamb - Türrahmen links - Cadre de porte gauche - Telaio montante sinistro della porta - Linkerstijl deurframe - Ukse vasak leng			1	66x80	1850
3	Right door jamb - Türrahmen rechts - Cadre de porte droit - Telaio montante destro della porta - Rechterstijl deurframe - Ukse parem leng			1	66x80	1850
4	Doorstep - Swelle - Barre de seuil - Soglia della porta - Deurdorpel - Lävepak			1	18x18	1418
5	Connection strip - Deckleiste - Baguette de battement - Profilo verticale della porta - Stulplijst - kokkuvaltsiliist			1	13x32	1812
6	Georgian bars - Sprossen - Croisillons - La griglia georgiana - Raamverdeling - Petteliistud			2	15x25	934
7	Georgian bars - Sprossen - Croisillons - La griglia georgiana - Raamverdeling - Petteliistud			2	15x25	536





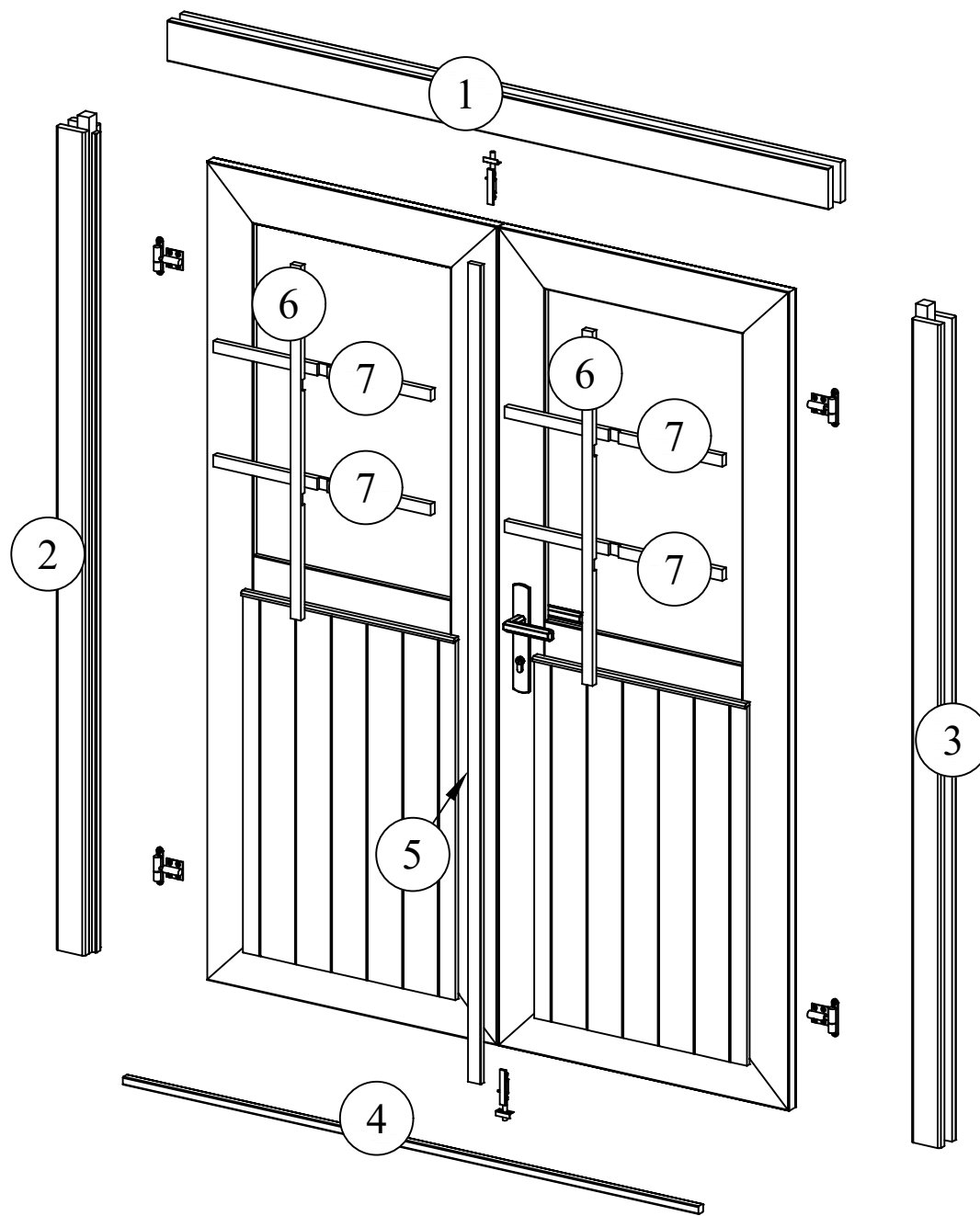

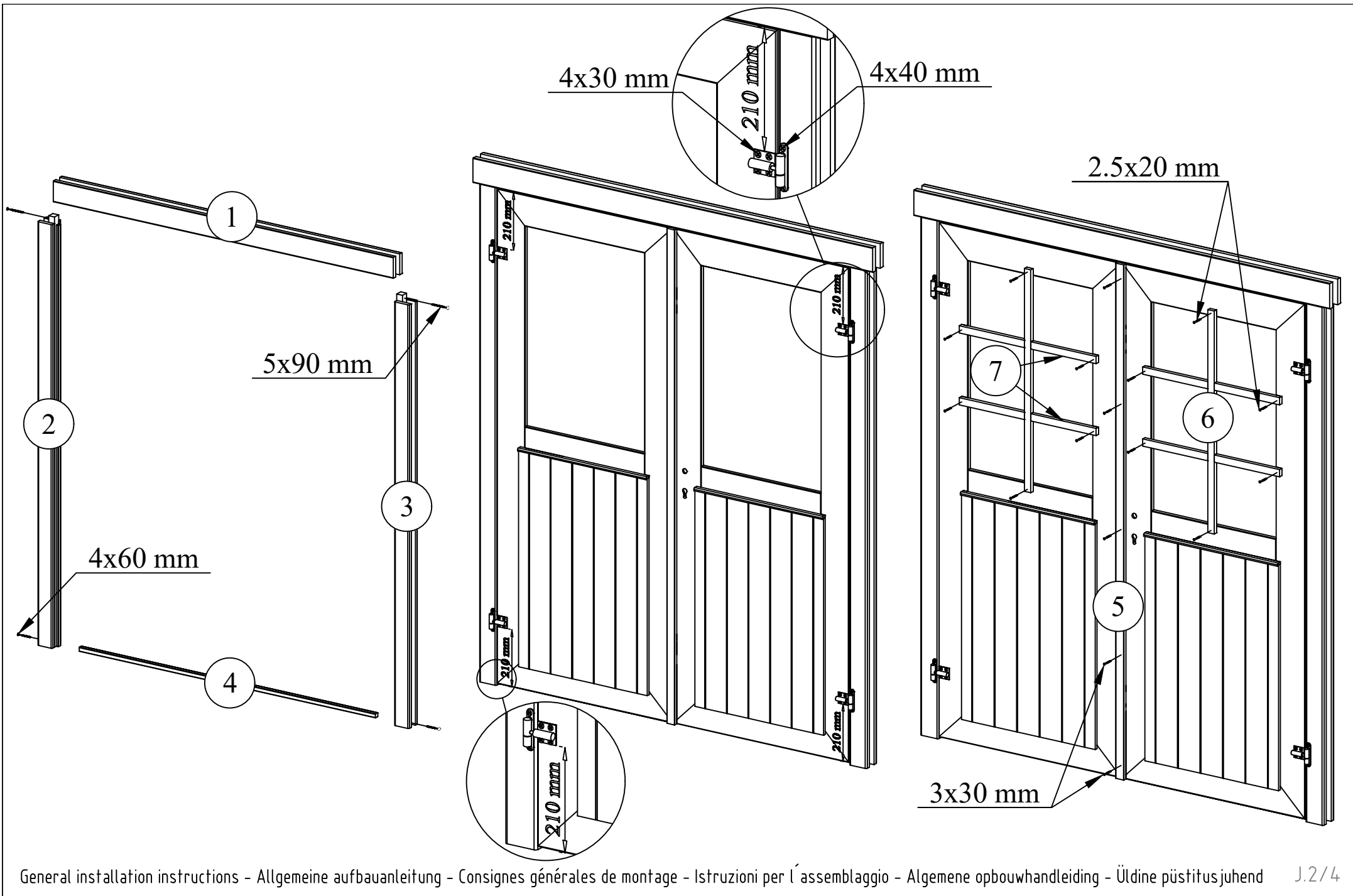

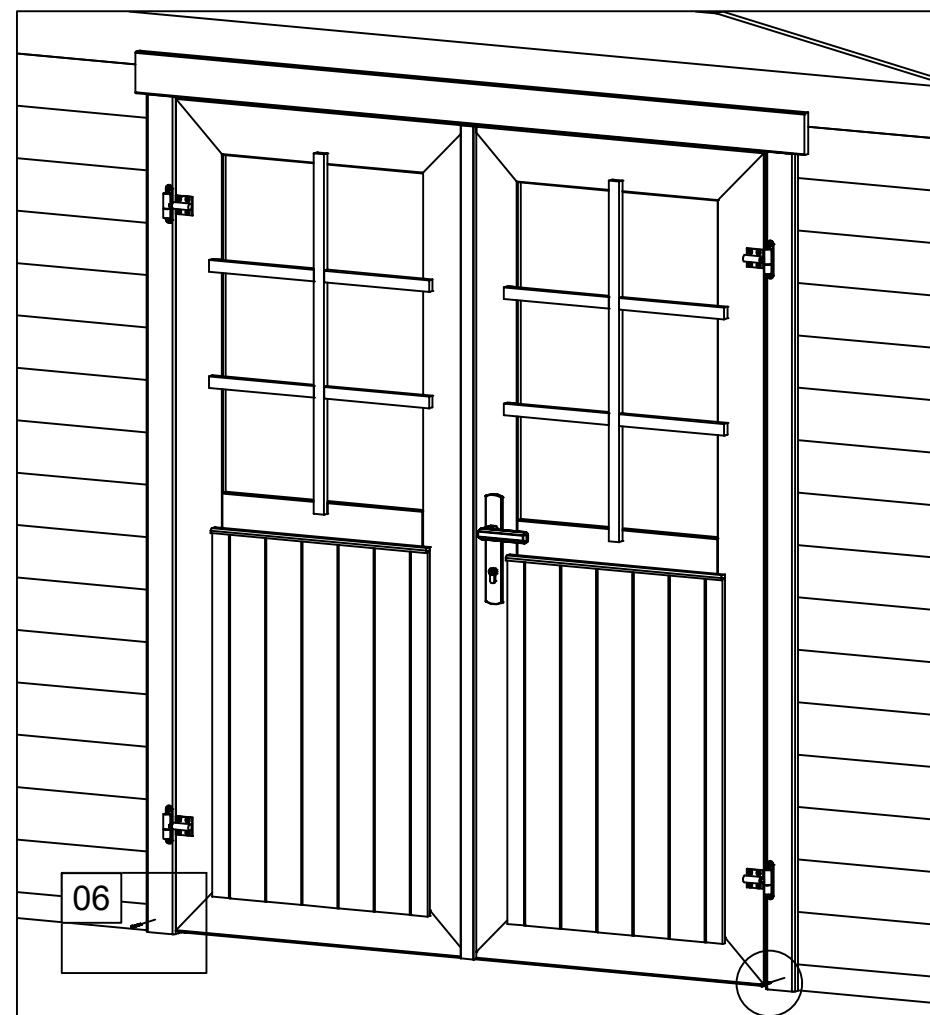
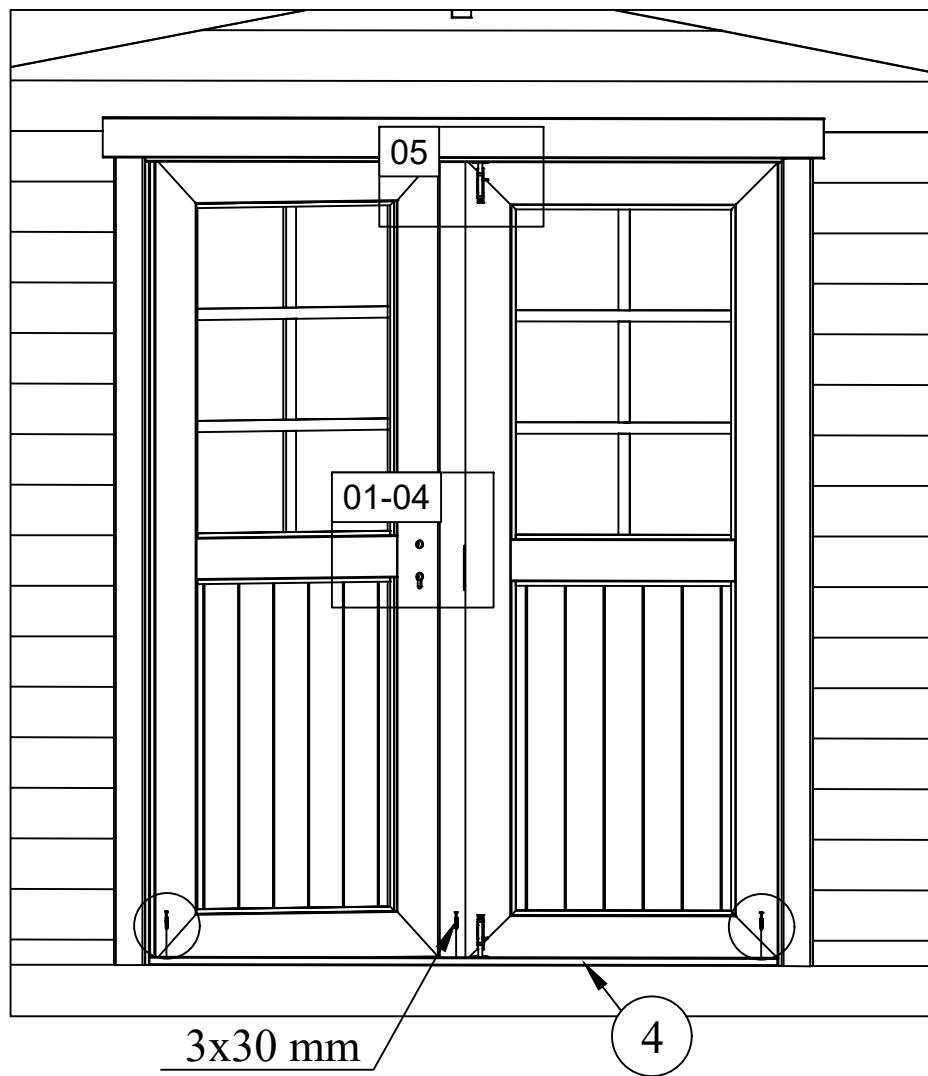

01



04



02



05



03



06

